

## Ceramics Product



Blanket



Board



Paper



Textile



Ceramics Fiber Moduel

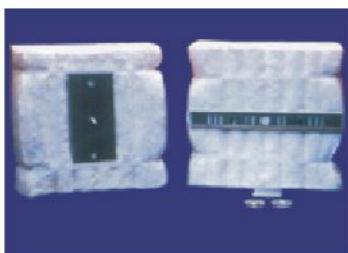

High Alumina Ceramic Tiles



Calcium Silicate Insul. Board

## Minerals

- Gypsum Imported (Iran/Oman) • High Grade Lime Stone • Cement • Clinker
- Fly Ash • Pet Cock / Coal/SAF Coal • Rock Phosphate • GBFS • Silica Sand

## Monolithics

- Refractory Castable • Firecement/Mortar/Paste • Bricks • Precast Shapes
- Fast Setting Castable • Thermocoat-M Refractory Coating Materials

## Safety Products

- Nomex Suit • Boiler Suit • Proban Suit



EXPORT TO  
COUNTRIES



PAKISTAN



U.A.E.



NEPAL



MALAYSIA



IRAN



MANUFACTURER  
EXPORTER  
IMPORTER  
TRADING

MOVABLE INLET CHUTE FOR THE CEMENT MILL  
FOR ENTERING IN TO FIRST CHAMBER OF CEMENT MILL



Clinker Sampler

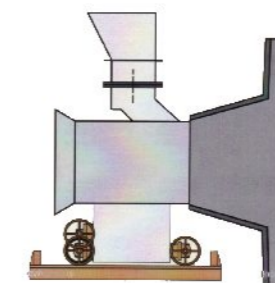

CHUTE IN  
NORMAL POSITION

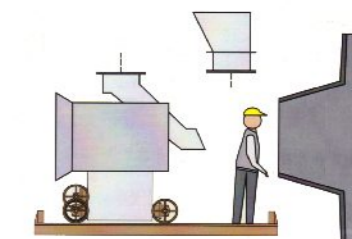

CHUTE IN MOVED ON WHEEL  
FOR SAFE ENTRY TO MILL



SS Anchor



Pan Mixer

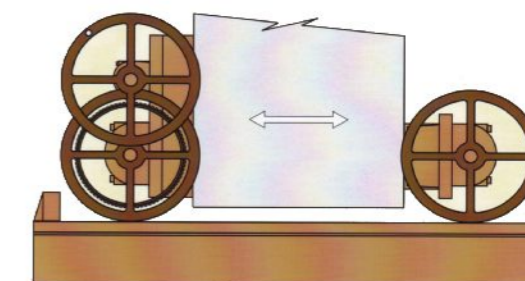

WHEEL ASSEMBLY



Diamond Saw  
Wheels



Refractory Brick Cutting Machine

AN ISO 9001 : 2008  
CERTIFIED COMPANY

REG. OFFICE :  
"JANAK", Mahavir Society,  
Behind Jethwa Rajput Hostel,  
PORBANDAR - 360 575.

Gujarat, India.

Mobile : +91 9825243130

AHMEDABAD BRANCH : MOBILE +91 9925153130

Email: Millenniempbr@yahoo.com, millenniummultitrade@gmail.com, www.mmtplindia.com

**Millennium**  
MULTI TRADE PVT. LTD.

CIN NO. U51900GJ2010PTC063392





**MMTPL**

SINCE 2000

**MANUFACTURER ■ TRADING  
EXPORTER ■ IMPORTER**

CIN NO. U51900GJ2010PTC063392

**Millennium  
MULTI TRADE PVT. LTD.**

AN ISO 9001 : 2008 CERTIFIED COMPANY

**MOVABLE INLET CHUTE  
FOR THE CEMENT MILL  
FOR ENTERING IN TO FIRST  
CHAMBER OF CEMENT MILL**

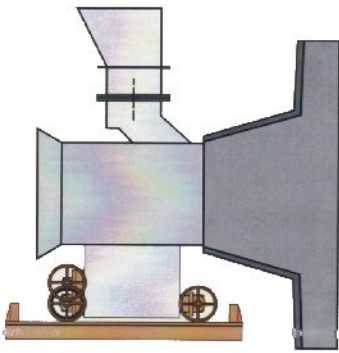

Chute In Normal Postion

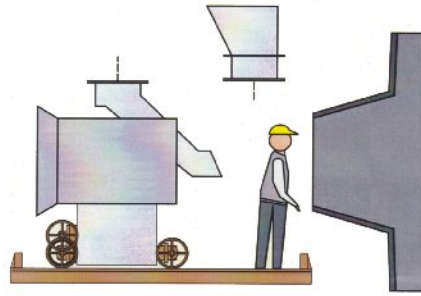

Chute In Moved On Wheel  
For Safe Entry To Mill

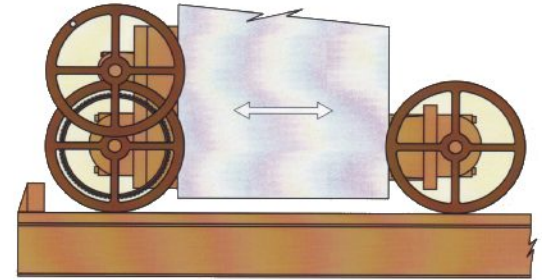

Wheel Assemble



Refractory Stainless Steel Anchor



Clinker Sampler

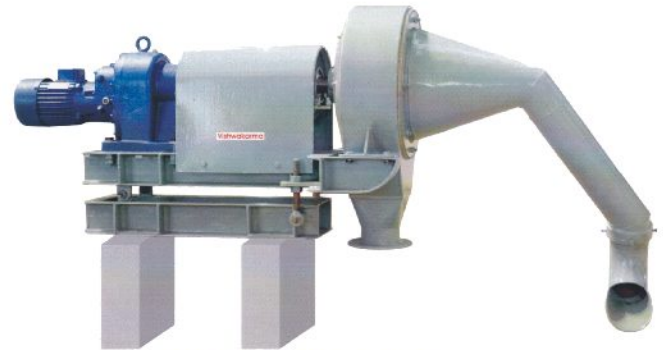

Pan Mixer



Refractory Brick Cutting Machine



Needle Vibrator

**REG. OFFICE :**

"JANAK", Mahavir Society, Behind Jethwa Rajput Hostel,  
PORBANDAR - 360 575. Gujarat, India. Mobile : +91 9825243130

**AHMEDABAD BRANCH :** MOBILE +91 9925153130

Email: Millenniempbr@yahoo.com, mmtpl@mmtplindia.com, manoj@mmtplindia.com

www.mmtplindia.com, www.millenniempbr.co.in

एन. एस. आई. सी.  
**NSIC**





## Ceramics Product



Blanket



Board



Paper



Textile



Ceramics Fiber Moduel

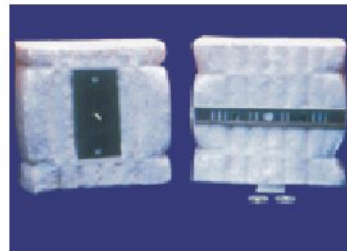

High Alumina Ceramic Tiles

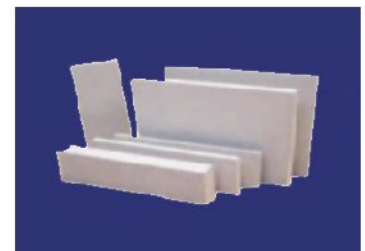

Calcium Silicate Insul. Board

## Minerals

- Gypsum Imported (Iran/Oman) • High Grade Lime Stone • Cement • Clinker
- Fly Ash • Pet Cock / Coal/SAF Coal • Rock Phosphate • GBFS • Silica Sand

## Monolithics

- Refractory Castable • Firecement/Mortar/Paste • Bricks • Precast Shapes
- Fast Setting Castable • Thermocoat-M Refractory Coating Materials

## Safety Products

- Nomex Suit • Boiler Suit • Proban Suit

**Industries Served : Cement, Ceramics, Steel, TPS, Coke Oven, Glass, Refinery.**

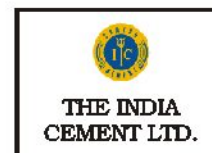
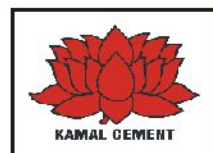

**EXPORT TO COUNTRIES**



IRAN



U.A.E.



NEPAL



MALAYSIA



PAKISTAN



# Millennium

## MULTI TRADE PVT. LTD.

AN ISO 9001 : 2008 CERTIFIED COMPANY



**MANUFACTURER ■ TRADING**  
**EXPORTER ■ IMPORTER**

### Company Profile :

We Millennium Multi Trade Pvt. Ltd.(mmtpl) Are Manufacturer, Exporter, Importer And Engineering Services(OEM-EMR) A Marketing Company Based At Porbandar-Ahmedabad, Gujarat, India Providing Solutions For Refractory/Monolithics/ Bricks And Refractory Anchors /Stainless Steel Fibres, Ceramic Fibers Moduls Anchors, Our Ultra Modern Infrastructure Facilities For Bulk Production To Meet The Urgent Requirement Of Customer Within The Time Frame.

### Mission :

To Provide The Best Solutions For All Type Of Refractory Anchors And Ss Fibers To Our Customers World Wide Employing The Best Quality And The Stipulated Time Delivery.  
All Type Of Refractory Anchors And Ss Fibers For Various Grade, Shapes, Diameter And Application As Per Drawing Designing And Specification. We MMTPL : Wide Range Of Refractory Anchors And Ss Fibers. Made Using High Grade Materials And Employing Latest Technology With International Quality Standards.

### Infra Structure :

The Plant Has An Installed Capacity Of 50 Lac Anchors And 500 Mt Fibers Per Year. 15000 Square Feet With State Of The Art Infrastructure.  
Hitech Sophisticated Range Of Mechanical Power Presses, Hydraulic Press, Hand Press, Welding Machine, Drilling Machine, Various Type Of Dies And Tools. Large Product Lime, Bulk Production Capacity. Customized Solutions, On Time Delivery.

### Quality And Testing :

Raw Material Testing Is One Of The Important Factor Which Determine The Quality Of Finished Products. We Test Our Incoming Raw Materials In In House Lab And In The Mid Of Manufacturing Process And We Perform A Dimensional Check On Randomly Drawn Samples From Each Lot At Each Stage To Ensure Best Quality Product To Our Customer.  
Packing & Forwarding : Good Quality Packaging Becomes An Imperative To Safely Deliver The Material To Customer. We Maintain The Standard Of Packaging With Showing The Complete Details Of MMTPL And Materials Packed. This Will Ensure To Identification Of The Materials. All Provide Export Packing On Pallets, Crate Or In Wooden Boxes. We Also Offer Customized Packing Options To The Customer.

Products Range : Plastic Caps, Ss Fabricated Articles,

## Refractory Anchor



### REG. OFFICE :

"JANAK", Mahavir Society, Behind Jethwa Rajput Hostel,  
PORBANDAR - 360 575. Gujarat, India. Mobile : +91 9825243130

**AHMEDABAD BRANCH :** MOBILE +91 9925153130

Email: Millenniempbr@yahoo.com, mmtpl@mmtplindia.com, manoj@mmtplindia.com

www.mmtplindia.com, www.millenniempbr.co.in

एन. एस. आई सी.  
**NSIC**





# Refractory Stainless Steel Fibers Melt Extract & Wire Cut

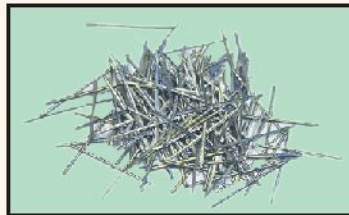

Stainless Steel Fibers are widely used in reinforcing monolithic refractories against thermal and mechanical shock by reducing cracking and spalling susceptibility. Stainless Steel Fibers are widely used in ceramic Processing, Primary metal, Power, Cement, Lime and Petrochemical Industries.

## SS FIBERS NON MAGNETIC & BRIGHT IN COLOR

### CHEMICAL COMPOSITIONS IN %

SS	C	SI	Mn	P	S	Cr	NI
310	0.08	1.50	2.0	0.045	0.03	24 to 26	19 to 22
304	0.08	1.0	2.0	0.045	0.03	18 to 20	8 to 10

### MECHANICAL COMPOSITION

SS Grade	Melting Temp.	Service Temp.	Tensile Strength MPa Min	Yield Strength 0.2 % proof(MPa)	Elongation (%In 50 mm) Min
310	1400 C	1100 C	550	245	45
304	1100 C	900 C	515	205	40

### TYPICAL DIMENSION AND ASPECT RATIO

SS Grade	Fiber Length	Typical Diameter	Typical Aspect Ratio	Typical No/Kg
310 & 304	25 mm	0.5 mm	50	25000 Approx

Grade	Length	Width	Thikness
304, 310, 430, 446	20, 25, 35, 50 Mm	0.5-1.0 Mm	0.2 To 0.75 Mm

#### Note :

■ This fibers are manufactured to the requirements of ASTM A820/A820M-06 Type III which specifies the following dimensional Tolerances

- Length and Equivalent diameter : +/- 10 % ● Aspect Ratio : +/- 15 %
- The dimensions of fibers are as per customer's requirement.
- Aspect ratio is calculated as fiber length/diameter

◆ We Also Manufacturer :

- All Type Hexmesh ● Hexmesh Accessories
- Fastners ● Turned & Pressed Components.

**Industries Served : Cement, Ceramics, Steel, TPS, Coke Oven, Glass, Refinery.**

### EXPORT TO COUNTRIES



IRAN



U.A.E.



NEPAL



MALAYSIA



PAKISTAN



SINCE 2000

**Millennium**  
MULTI TRADE PVT. LTD.  
CIN NO. U51900GJ2010PTC063392

"JANAK", Mahavir Society,  
Behind Jethwa Rajput Hostel,  
PORBANDAR - 360 575.  
Gujarat, India.

**MANUFACTURER ● EXPORTER ● IMPORTER ● TRADERS**  
Mobile : +91 9825243130 ● www.mmtplindia.com  
AHMEDABAD BRANCH : MOBILE +91 9925153130

Email: Millennlempbr@yahoo.com, millenniummultitrade@gmail.com



# MOVABLE INLET CHUTE FOR THE CEMENT MILL FOR ENTERING IN TO FIRST CHAMBER OF CEMENT MILL

One has to enter through inlet chute or through manhole, which is cumbersome, unsafe & time taking. An innovative thought, by mounting designed wheel assembly whole chute can move on rail for easy entering and looking in to.

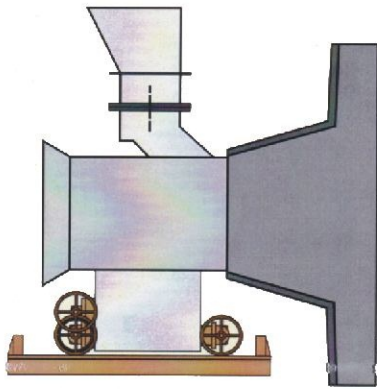

CHUTE IN NORMAL POSITION

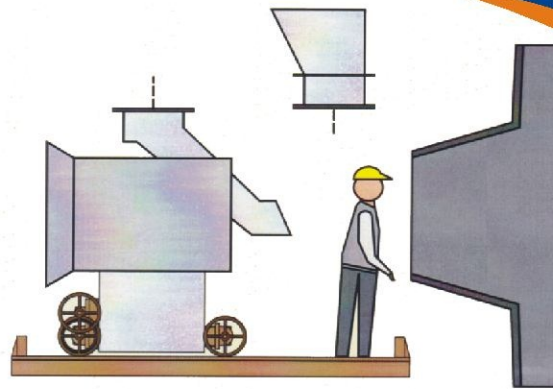

CHUTE IN MOVED ON WHEEL - FOR SAFE ENTRY TO MILL

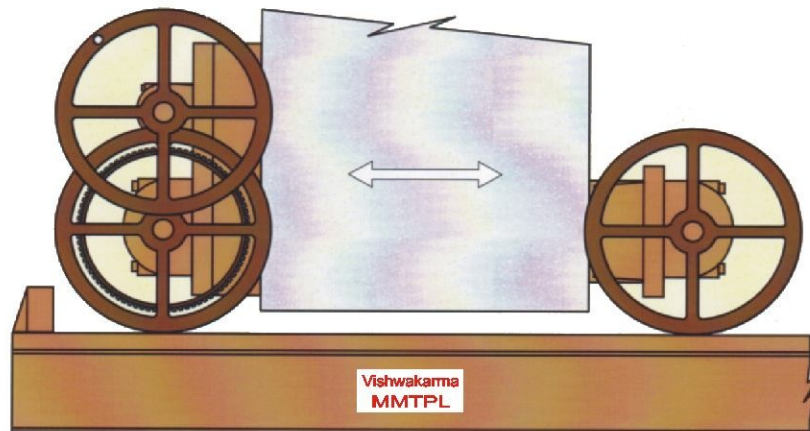

WHEEL ASSEMBLE

- Easy to move, Most safe and time saving.
- Gear and Pinion arrangement, makes it possible to move the chute by one person only.
- Just open inlet flange bolts and rotate the hand wheel, chute moves easily
- Proved technology and working satisfactory

**For any other type of inlet chute, arrangement can be Design and Supply**

Exclusive  
Marketing  
Right of



**Millennium**  
MULTI TRADE PVT. LTD.  
CIN NO. U51900GJ2010PTC063392

"JANAK", Mahavir Society,  
Behind Jethwa Rajput Hostel,  
PORBANDAR - 360 575.  
Gujarat, India.

**MANUFACTURER • EXPORTER • IMPORTER • TRADERS**  
Mobile : +91 9825243130 • [www.mmtplindia.com](http://www.mmtplindia.com)  
AHMEDABAD BRANCH : MOBILE +91 9925153130

Email: [Millenniempbr@yahoo.com](mailto:Millenniempbr@yahoo.com), [millenniummultytrade@gmail.com](mailto:millenniummultytrade@gmail.com)

AN ISO 9001 : 2008  
CERTIFIED COMPANY

एन. एस. आई. सी.  
**NSIC**



**MINERAL**  
GYPSUM  
LIME STONE  
FLY ASH  
CLINKER  
COAL-COKE  
CEMENT-CLINKER  
GBFS  
SILICA SAND

**MACHINES**  
SS ANCHORS  
BRICK CUTTING MACHINE  
PAN MIXER  
DIAMOND SAW WHEEL  
WINCH MACHINE  
GRINDING MEDIA SORTING  
CHARGING MACHINE

**MONOLITHICS**  
REFRACTORY CASTABLE  
ALL TYPE OF BRICKS  
PRECAST SHAPES  
MORTAR/FIRECEMENT/PASTE  
REFRACTORY COATING MATERIAL  
FAST SETTING MONOLITHICS  
GEL BONDED CASTABLE

**CERAMICS INSULATIONS**  
CERAMIC FIBER BLANKET/ROLL/  
PAPER/BOARD/ROPES/BULK/LOOSE  
HIGH ALUMINA CERAMIC TILE/LINERS  
CALSIUM SILCATE INSULATION  
BLOCKS/BRICKS  
COBALT BLUE GALSS  
GRINDING AID CHEMICALS.

**PAINT & SAFETY**  
ANTI CORROSIVE HIGH  
TEMP RESISTANT  
INSULATING PAINT  
FIRE SUIT/  
ALUMINISED PROXIMITY  
SUIT/APRON/  
NOMEX SUIT



# CLINKER SAMPLER

Easy and Safe way to collect the Clinker sample  
from Deep Pan Conveyor (DPC)

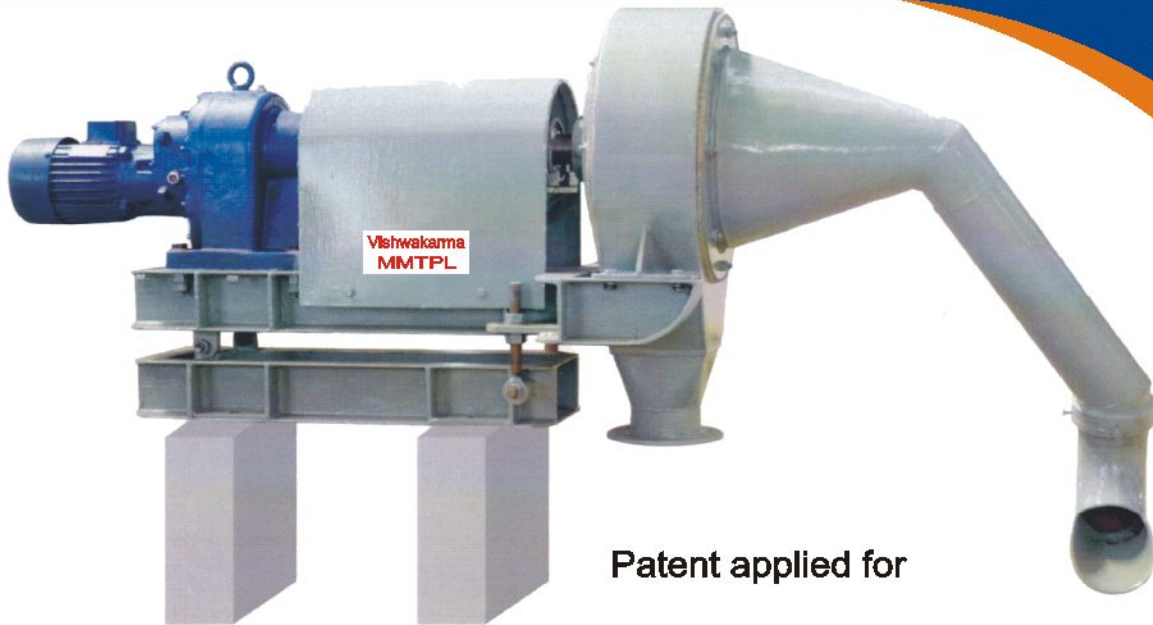

Patent applied for

## Features:

- ◆ Motorized with remote control panel at safe location.
- ◆ Totally Enclosed system with seals on both sides of rotation arm.
- ◆ Easy to install. Depth of collecting mouth can be adjusted as per the requirement.
- ◆ Compatible with two sizes DPC viz., 800 to 1000 mm wide and 1200 to 1500 mm wide.
- ◆ The discharge can be extended by attaching extra pipe.
- ◆ Completely does away with manual collection of sample from D P Conveyor, which is dangerous and unsafe

**For any other raw Materials sample collection arrangement can be Design and Supply**

Exclusive  
Marketing  
Right of



SINCE 2000

**Millennium**  
MULTI TRADE PVT. LTD.  
CIN NO. U51900GJ2010PTC063392

"JANAK", Mahavir Society,  
Behind Jethwa Rajput Hostel,  
PORBANDAR - 360 575.  
Gujarat, India.

**MANUFACTURER • EXPORTER • IMPORTER • TRADERS**

Mobile : +91 9825243130 • [www.mmtplindia.com](http://www.mmtplindia.com)

AHMEDABAD BRANCH : MOBILE +91 9925153130

Email: [Millenniempbr@yahoo.com](mailto:Millenniempbr@yahoo.com), [millenniummultytrade@gmail.com](mailto:millenniummultytrade@gmail.com)

**Ambuja  
Cement**

**ACC**  
ACC LIMITED

**UltraTech**  
CEMENT  
The Engineer's Choice

**LAFARGE**  
CEMENT

**Dalmia**

**SANGHI  
CEMENT**  
**Binani**  
SHREE CEMENT LIMITED